

TCB4 Upgrade Kit for LBB 3500/00, /10 and /30

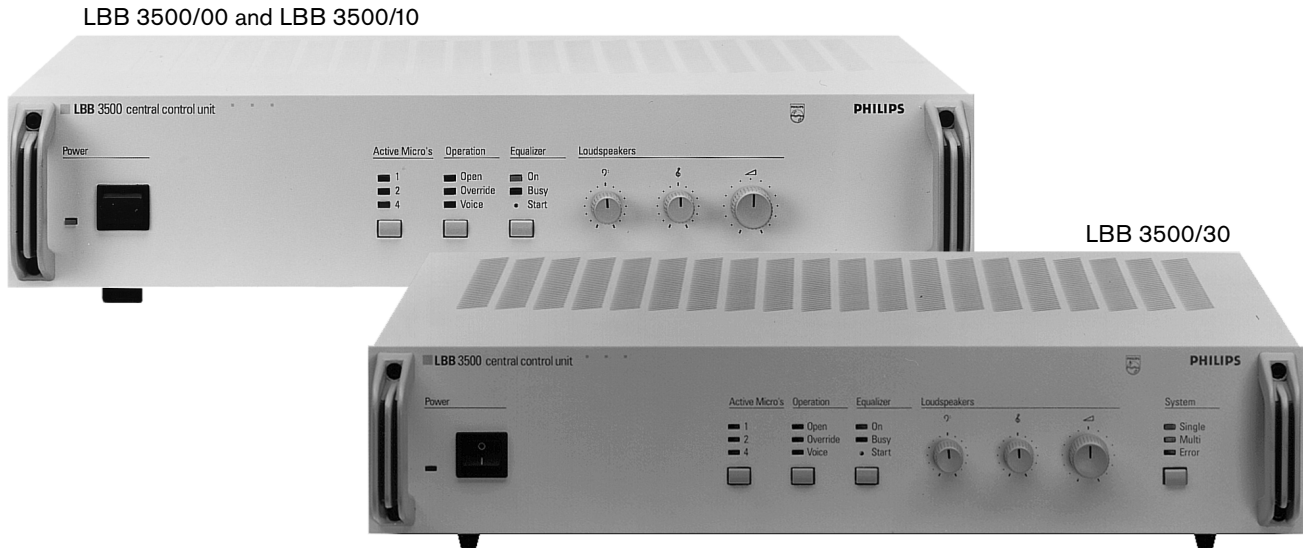

Security Systems

Installation Instruction
en | LBB 3519/20



Chapter 1 . Upgrade Kit LBB 3519/20

Introduction

The upgrade kit LBB 3519/20 is intended for upgrading of the following DCN Central Control Units:

- LBB 3500/00 (D)
- LBB 3500/10 (D)
- LBB 3500/30 (D)

The upgrade kit LBB 3519/20 (Trunk Communication Board (TCB 4)) once installed in the Central Control Units provides the CCUs' with a high speed serial RS 232 port. This port can be used for either 'DIRECT' connection to a DCN control PC, camera control, test/diagnostic purposes or for remote control.

The TCB4 has two Ports, Port 1 and Port 2. Both Ports can be used if a second hole is made at the rear of the CCU housing to accommodate the second 9-pole D-type connector.



NOTE: If a second port is required, then an additional interconnection cable is also required. This cable is ordered separately under Code No. 3922 156 24090, through your local Bosch supplier.

REMARKS:

1. Using the 'DIRECT' connection method the PC-Network card LBB 3510/00 is NO longer required.
2. If a 'DIRECT' connection is made between the Control PC and the CCU, the PC operator has no connection to the PC for headphone or intercom handset. Additional DCN hardware is required for the operator if these functions are required. Use can be made of DCN table-top or flush-mounted hardware depending on the requirements.

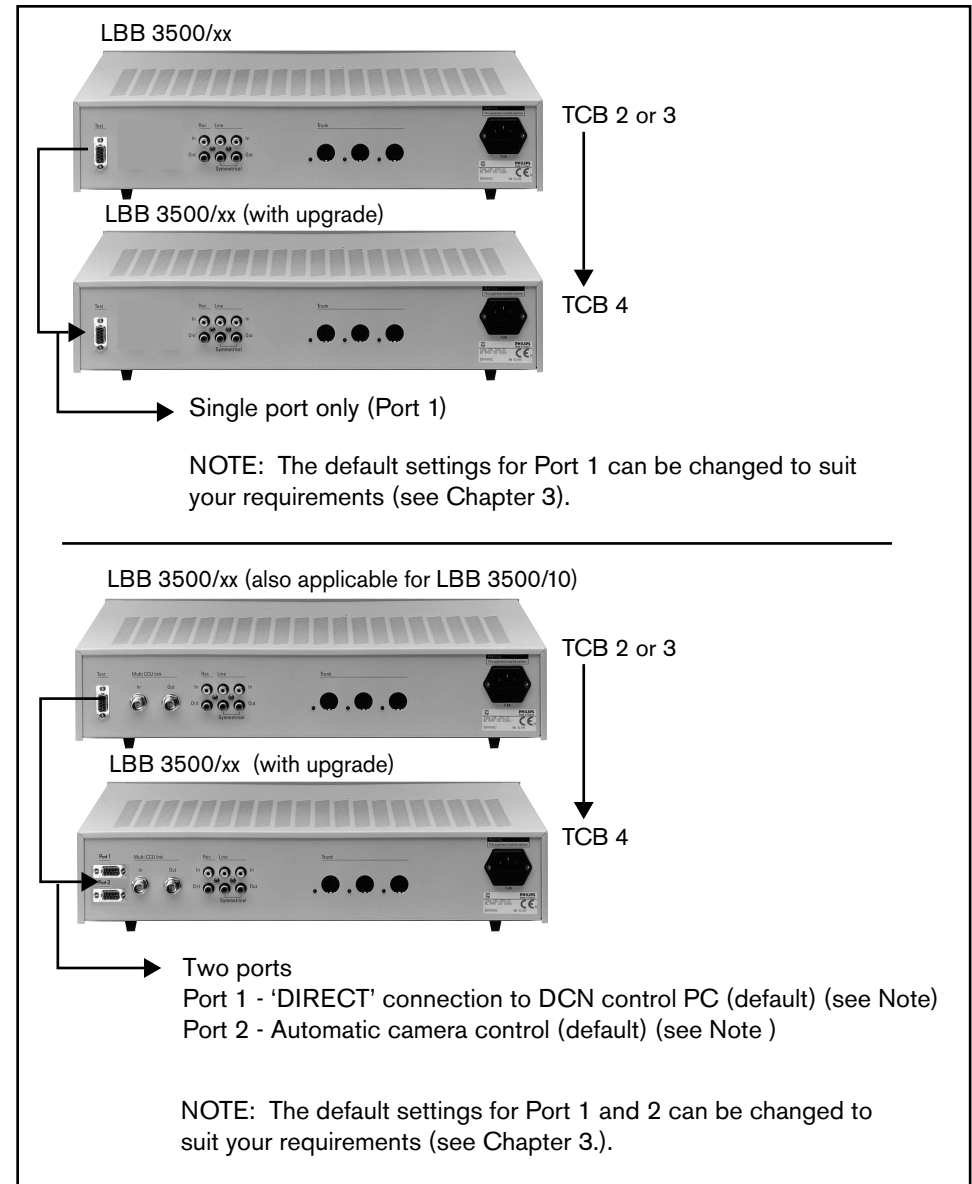

FIGURE 1-1 CCU upgrade kit LBB 3519/20

1.1 Before you Begin



WARNING: Before performing any of the procedures described in this document that require you to remove the top-cover of the CCU,

1. Before removing the top cover of the CCU, disconnect the mains supply and remove the mains cable from its source and from the rear of the CCU.
2. Disconnect any peripherals connected to the CCU
3. The TCB4 upgrade interface card is shipped in antistatic packaging for protection from electrostatic damage.



CAUTION: Before unwrapping the antistatic packaging, ground yourself by touching any unpainted metal surface on the Central Control Unit. This procedure discharges static electricity that might harm the interface card.

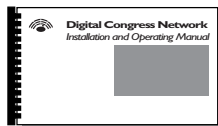

REFERENCE: If available refer also to Chapter 4 of the latest edition of the DCN Installation and Operating Manual. (Code No. 3922 988 433xx).

1.2 INSTALLING the TCB4 Interface card

1. Your upgrade kit includes:
 - 1 x TCB4 interface card
 - Interconnection (ribbon) cable terminated with a 9-pole D-type connector at one end and a Micromatch connector at the other end.



NOTE: If two ports are required, then an additional interconnection cable is also required. This cable is ordered separately under Code no. 3922 156 24090, through your local Bosch supplier.

Installation procedure



1. Remove the top-cover from the CCU.
2. Locate the TCB (version 2 or 3). For location of the TCB see [Fig 1-1](#).
NOTE: For Multi-CCUs type LBB 3500/30 carefully remove the 'Multi-CCU' card from the TCB card. The TCB is located under the 'Multi-CCU' card.
3. Remove all interconnection cables from the TCB.
4. Remove the 6 screws securing the TCB,
5. Remove the TCB.

Once the TCB 2 or 3 is removed proceed as follows:

Minor modifications, (i.e. widening the holes to accommodate the 9-pole D-type connector(s)) are required at the rear of the CCU. If the upgrade includes two Ports, then an additional hole is required to accommodate Port 2.

1. Remove the TCB from its packaging (see 1.1 Before you Begin)
2. Position the TCB4 in place and secure using its 6 securing screws.
3. Position and secure the 9-pole D-type connector(s) in their modified hole(s).
4. With reference to [FIGURE 1-1](#) and [FIGURE 2-1](#) connect Port 1 and if applicable Port 2.
5. Connect the TCB4 to both I/O control boards.
6. Double check connections according to [FIGURE 1-1](#) and [FIGURE 2-1](#).

1.3 SET-UP of the TCB4 Interface card

To ensure correct operation of the TCB4, the following settings are required:

1. DIP-switch S14 must be set, to configure the communication protocol and baud rate used on Port 1 and Port 2 ([see Chapter 3](#)).
2. DIP-switch S9 must be set to configure the boards functionality ([see Chapter 2.1](#)).
3. Jumpers X13 and X14 must be set ([see Chapter 2.2](#)).



NOTE: Once the TCB4 has been successfully installed in the CCU, replace the top-cover and connect the mains supply to the CCU. Check the CCU for correct operation. If the CCU functions correctly, the CCU should be switched ON for at least 24 hours to charge the back-up battery located on the TCB4.

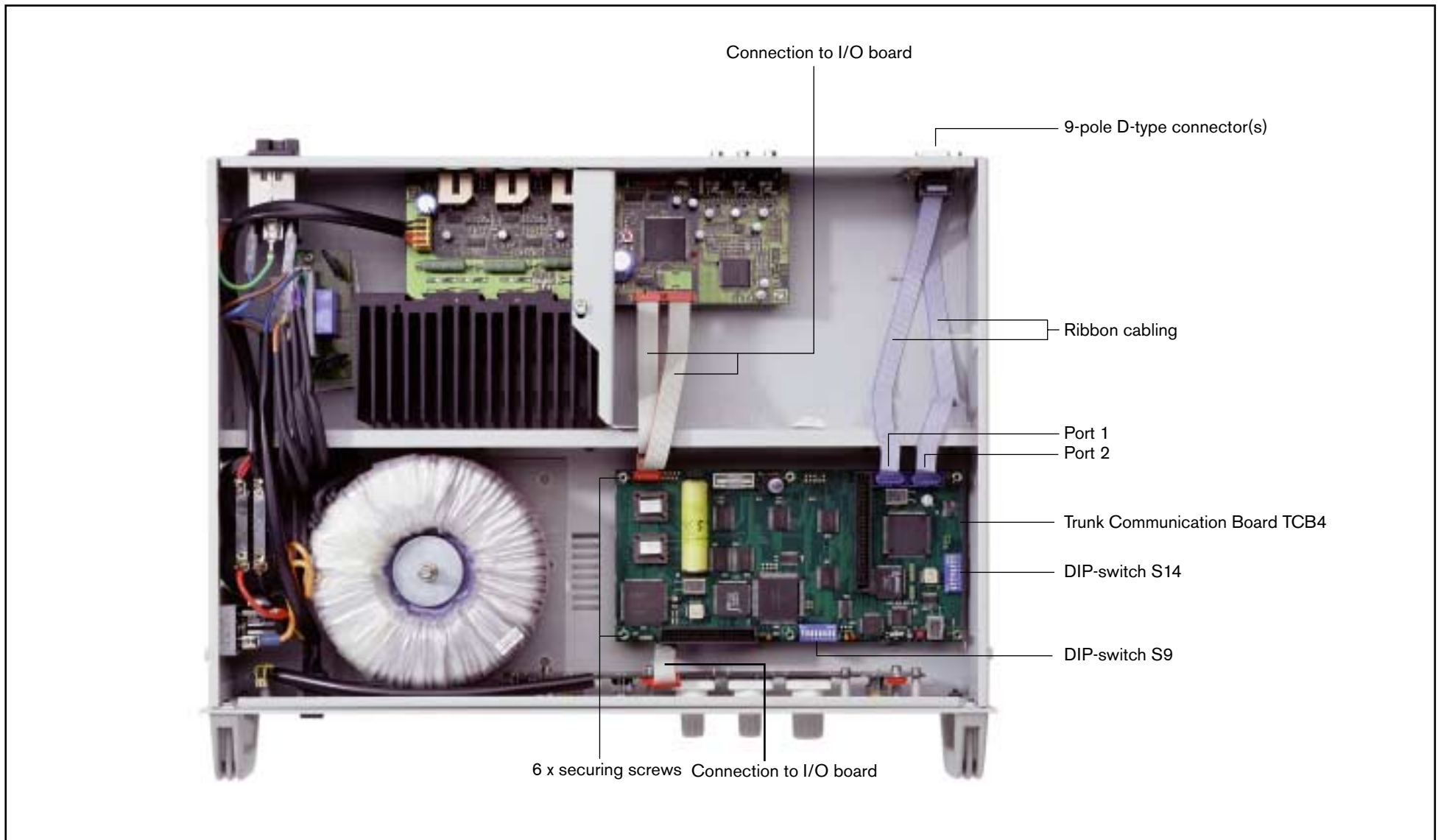

FIGURE 1-2 Internal view of CCU after upgrade

Chapter 2. Trunk Communication Board (TCB4)

Key to symbols (fig.2-1) :

- 1 Jumper X14 (see Table 2.2)
- 2 S14 DIP-switches 1 - 8 (see Chapter 3)
- 3 S10 Push-button switch to reset the Central Control Unit during servicing.
- 4 Three LEDs (left to right) green/yellow/red. Normally the green/yellow LEDs flash in sequence, indicating the software is running. Red LED illuminates during system reset.
- 5 S9 DIP-switches 1 - 8 (see Chapter 2.1)
- 6 Yellow LED indicates Digital Signal Processing (DSP) software is running.
- 7 Connector for multi-trunk board (used only in the multi-CCU)
- 8 Sockets for inserting flash EPROM (even)
- 9 Sockets for inserting flash EPROM (odd)
- 10 SRAM back-up battery 3.6 V (life-time 5 years min.)
- 11 Jumper X13 (see Table 2.2)
- 12 Fuse 3.15 amp (delayed)
- 13 Connector for multi-trunk board (used only in the multi-CCU LBB 3500/30)
- 14 Serial RS232 Port 1
- 15 Serial RS232 Port 2

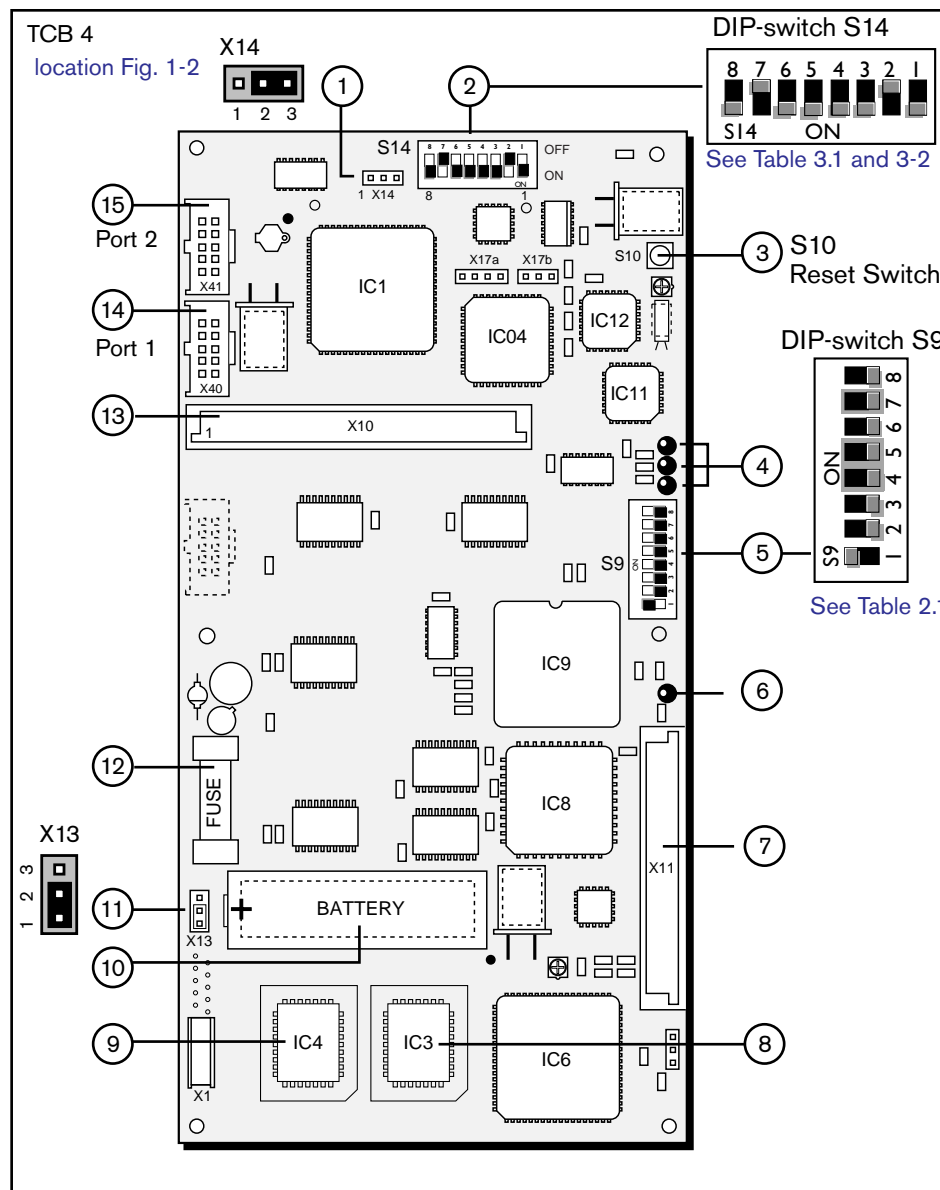

FIGURE 2-1 Layout 'Trunk Communication Board (TCB 4)

2.4 S9 DIP-Switch settings

See [fig. 2-1](#) for location, and [Table 2.1](#) for functionality of the DIP-switches.

Table 2.1 : S9 DIP-switch settings

TCB4		
SW 1	ON*	Chairman priority tone ON (default).
	OFF	Chairman priority tone OFF
SW 2	ON	Audio 'Mix-Minus' mode activated in combination with SW3 = OFF
	OFF*	Normal Operation (default).
SW 3	ON	Audio 'Insertion' mode activated in combination with SW2 = OFF
	OFF*	Normal Operation (default).
SW 4	OFF	Reserved (IMPORTANT : must not be changed)
SW 5	OFF	Reserved (IMPORTANT : must not be changed)
SW 6	ON	Active microphones and request will be permanently switched off if the priority function of the chairman unit is used.
	OFF*	Active microphones will be switched off temporarily if the priority function of the chairman unit is used (default).
SW 7	OFF	Reserved (IMPORTANT : must not be changed)
SW 8	ON	Switching on the CCU will activate the BOOT software, this makes a new download possible. All memory settings will be erased and returns to the default settings. The unit addresses will not be erased.
	OFF*	Normal operation (default).

* = default setting

DIP switch S9 (default settings)

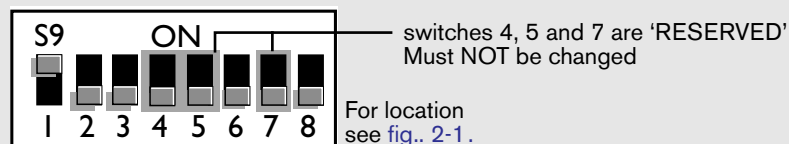

2.5 Jumper settings

See [fig. 2-1](#) for location, and [Table 2-2](#) for functionality of the jumpers.

Table 2.2 : Jumper settings

TCB4	Default	Function
X13	1 & 2	Jumpered to provide SRAM Battery back-up Open when removing back-up battery. (Position 2 & 3)
X14	1 & 2	Watchdog active Open for service purposes. (Position 2 & 3)

Chapter 3. CCU Protocol and Serial Port settings



NOTE: It is possible to select 'Full' protocol on both Port 1 and Port 2. However this is NOT recommended due to processing power and memory limitations.

For location of DIP-switches see [fig. 2-1](#)

3.1 LBB 3500/xx (TCB 4) - Port 1 : DCN Control PC Port 2 : Camera Control

In a single (stand-alone) CCU systems two serial COM-ports (Port 1 and Port 2) are available. Both ports can be individually configured. Default settings are;

- 8 data bits
- No parity check
- 1 Stop bit

Table 3.1 : LBB 3500/xx Protocol settings

DIP-switch S14	Port 1		Port 2	
	Switch	Switch	Switch	Switch
	DP-1	DP-2	DP-5	DP-6
Simple (Open interface)	OFF	OFF	OFF	OFF
Terminal	OFF	ON	OFF	ON
Full	ON*	OFF*	ON	OFF
Camera control	ON	ON	ON*	ON*

* default settings

Table 3.2 : LBB 3500/xx Baud rate settings

DIP-switch S14	Port 1		Port 2	
	Switch	Switch	Switch	Switch
	DP-3	DP-4	DP-7	DP-8
9.6 K	OFF	OFF	OFF	OFF
19.2 K	OFF	ON	OFF*	ON*
57.6 K	ON	OFF	ON	OFF
115.2 K	ON*	ON*	ON	ON

* default settings

DIP-switch S14 (default settings)

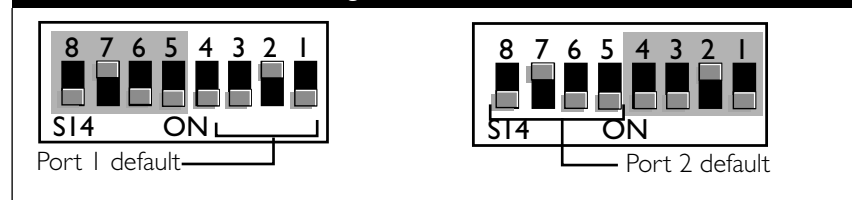

For more information please visit www.boschsecuritysystems.com

© 2003 Bosch Security Systems B.V.
Data subject to change without notice
April 03 | 3922 988 97112 en

BOSCH